



Route Z4-Z.I. Saint Gobain
1009 Jebel Jeloud-Tunisia
Tel. : (+216) 71 483 166
E-mail : contact@labtech.com.tn
Web : www.labtech.com.tn

Science Together

55 Years
Science Together



Programm

1. What is FPLC?

Concept and systems

2. How to purify?

Overview of common separation modes, applications and purification strategies

3. Troubleshooting

Tips and tricks for FPLC Users

4. Application Highlight: Automized 2-Step antibody purification

5. Discussion and Farewell



Route Z4-Z.I. Saint Gobain
1009 Jebel Jeloud-Tunisia
Tel. : (+216) 71 483 166
E-mail : contact@labtech.com.tn
Web : www.labtech.com.tn

What is FPLC?

Concept and systems

55 Years
Science Together



Pressure

HPLC

vs

FPLC



Scope

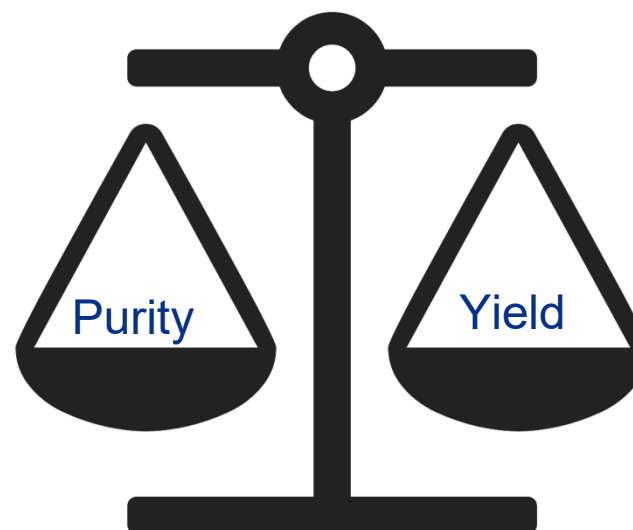
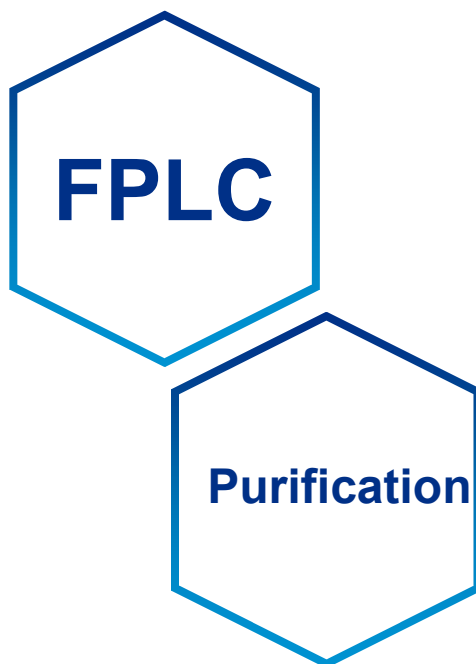

Purification

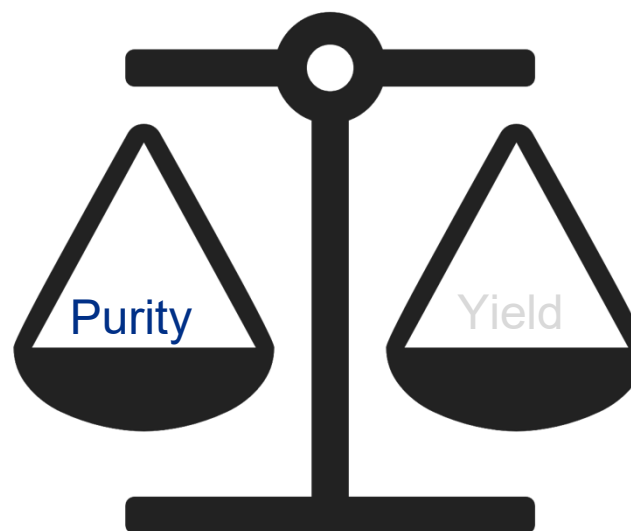
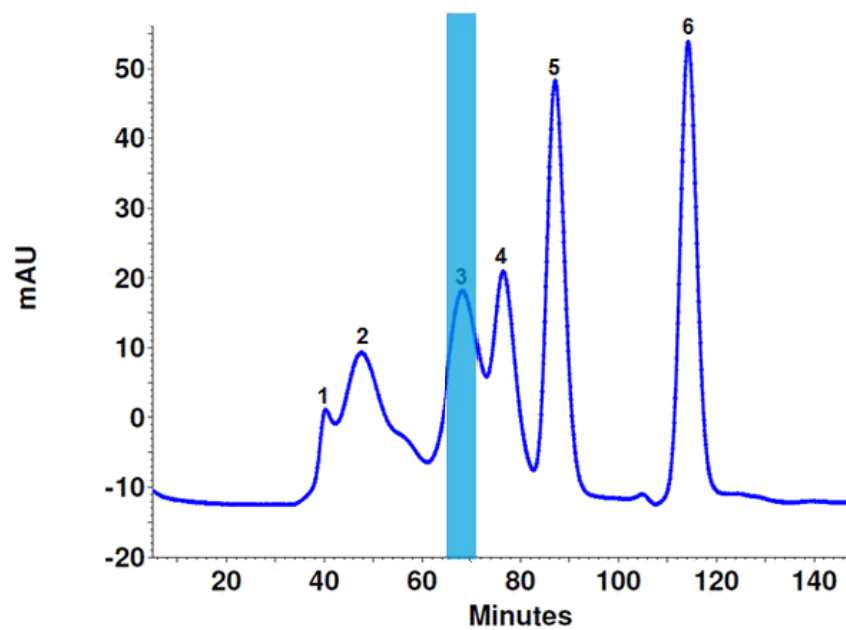

Purification

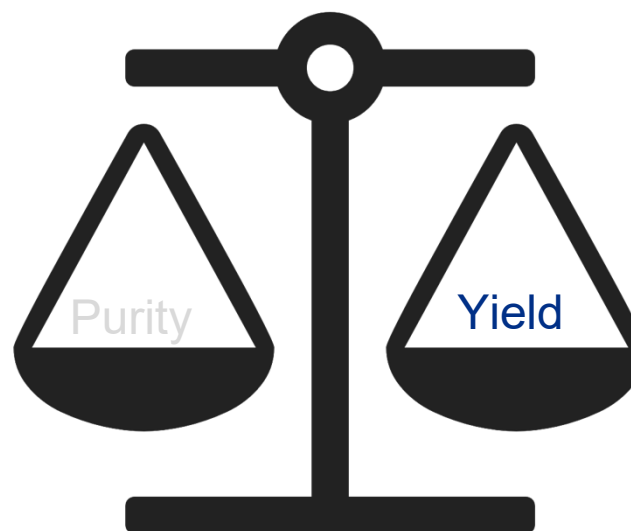
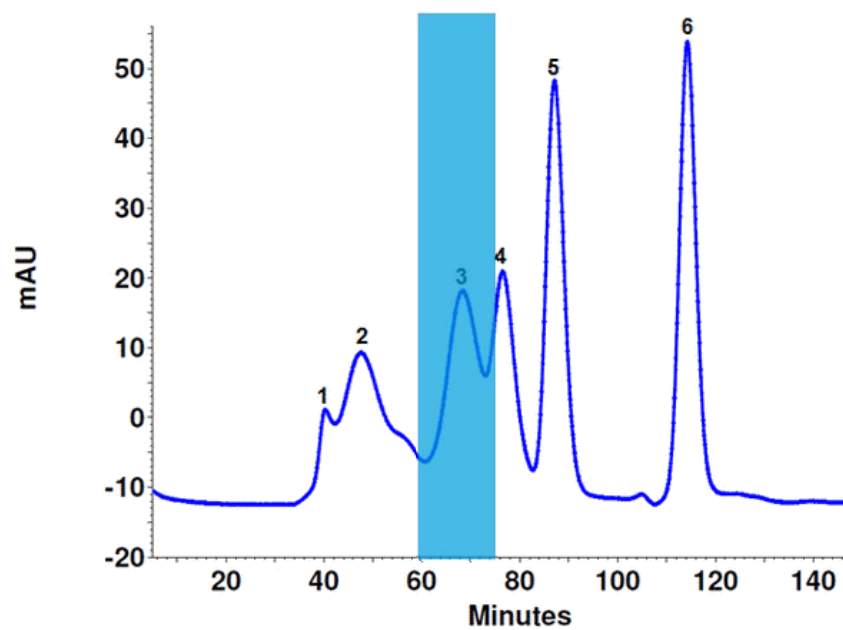

Samples

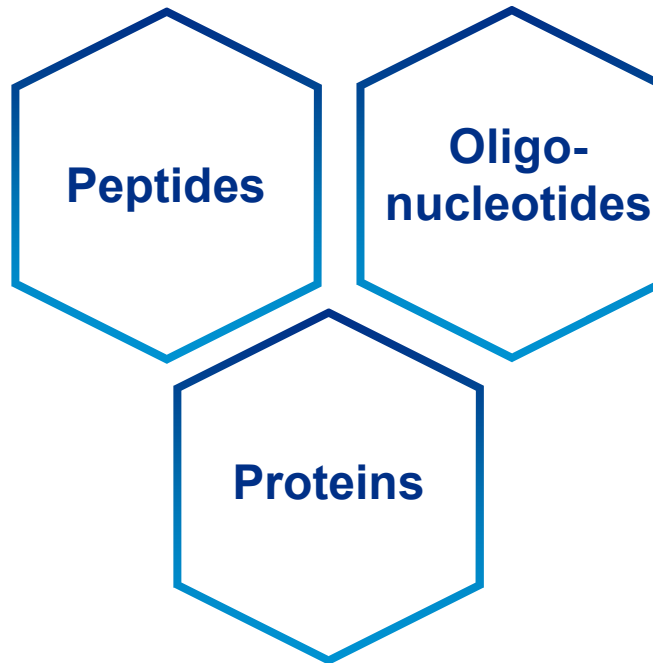

Samples

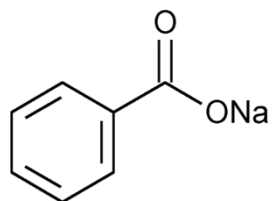

VS

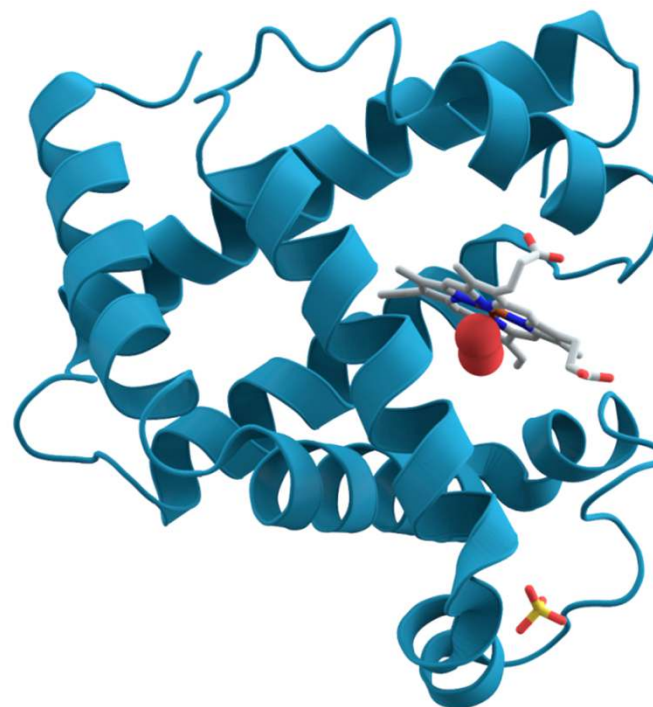

Native conditions

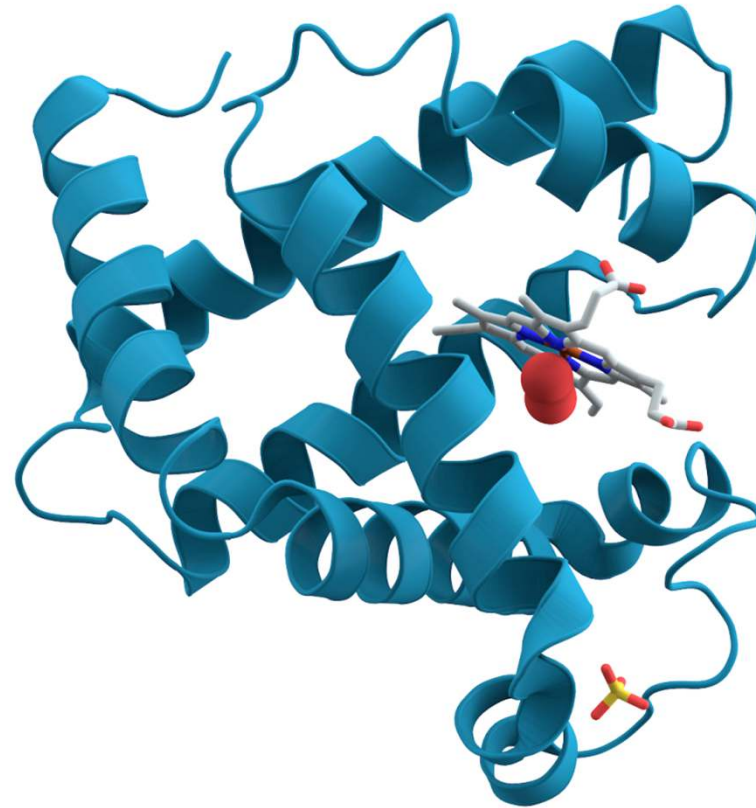

Native conditions

**Very
sensitive to
temperature**

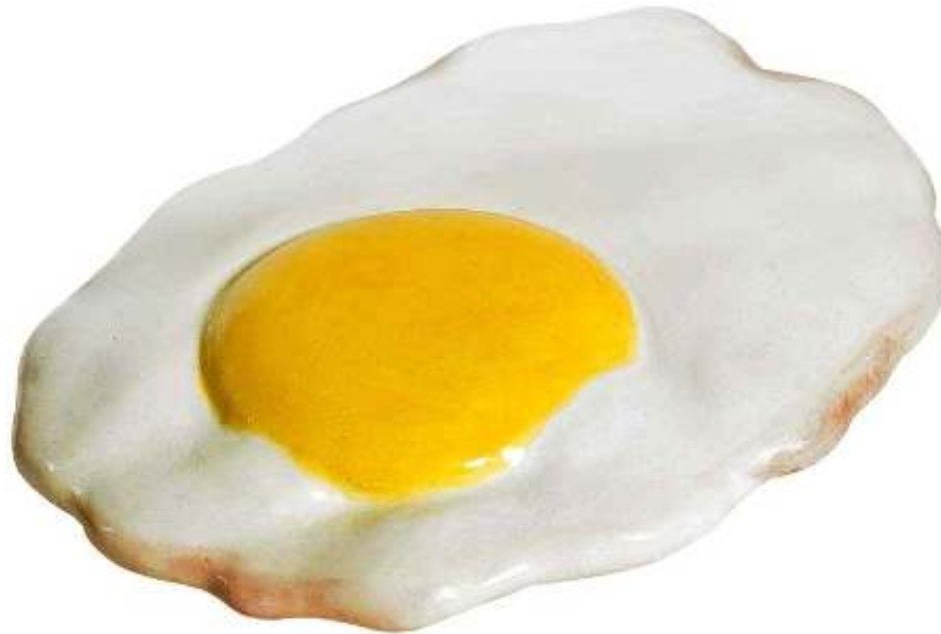

Native conditions



VS



Biocompatibility

**Classical
HPLC**

**Stainless steel
interferes with
purification**



Biocompatibility

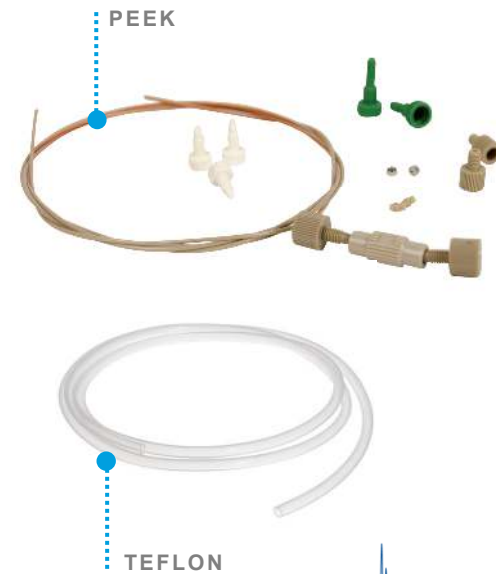

55 Years
Science Together

Phases/Materials

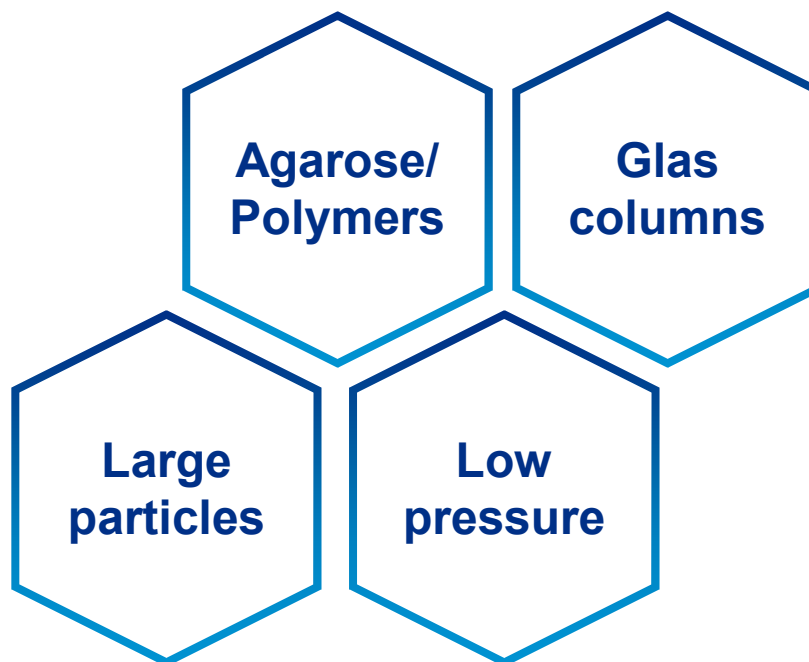

Software

Analytical software

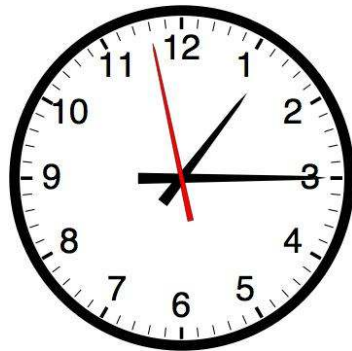

FPLC software

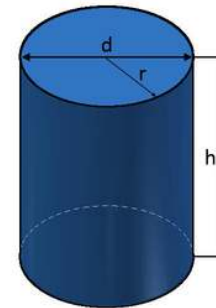

Software

Programming Mode

Time: min h
 Volume: µl ml l
 Column Volume µl ml l

Volume Calculator

Length: [cm] 

Diameter: [cm]

The FPLC system

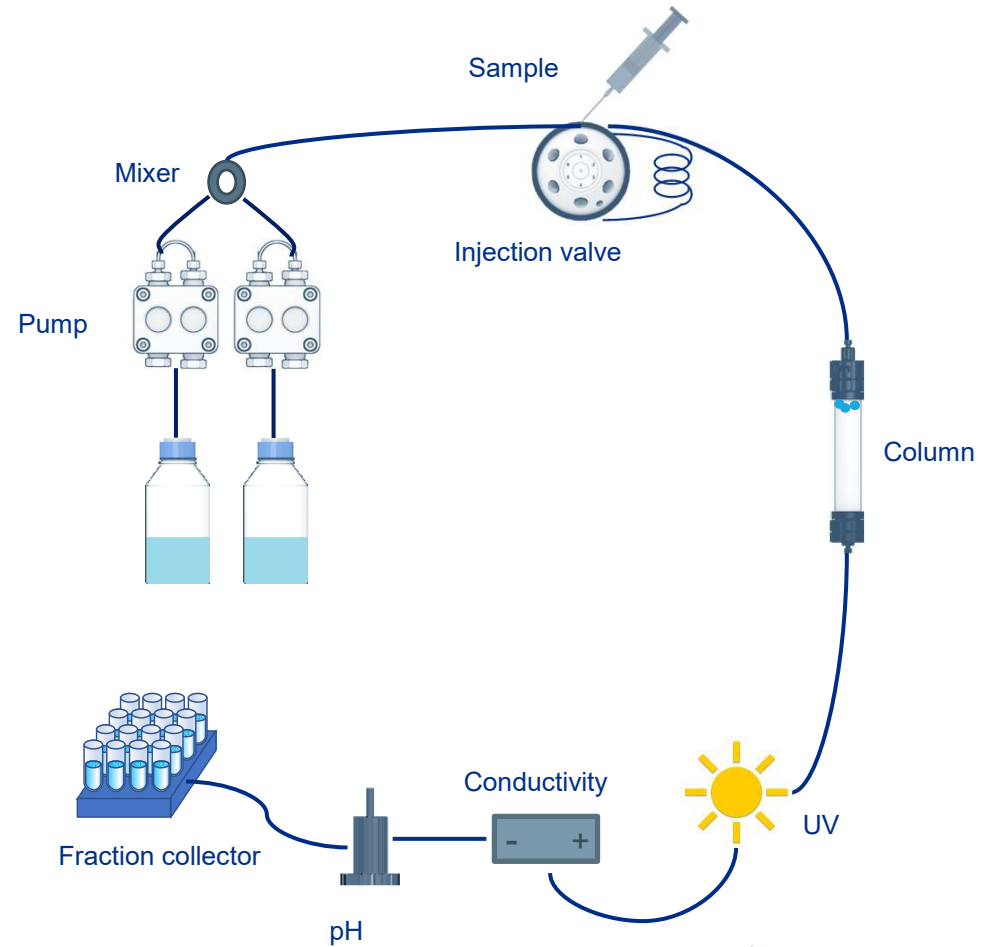
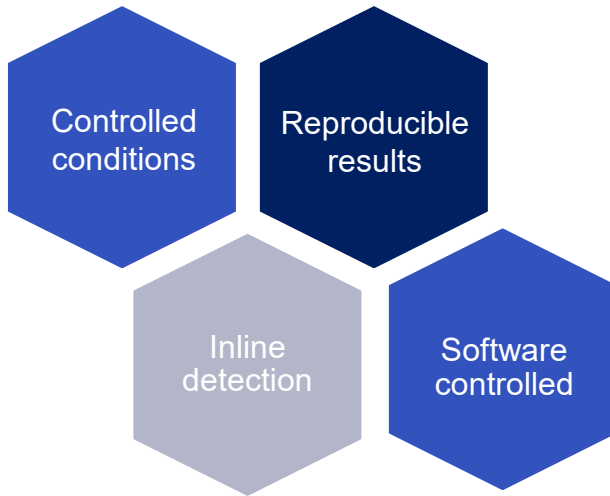

The pump

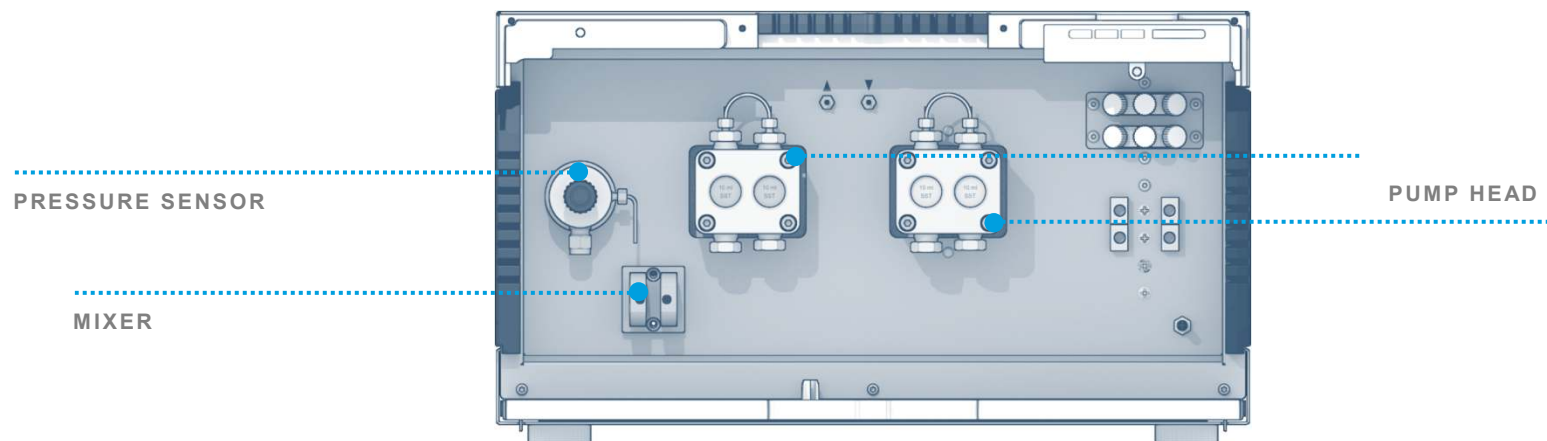

isocratic

gradient

The pump

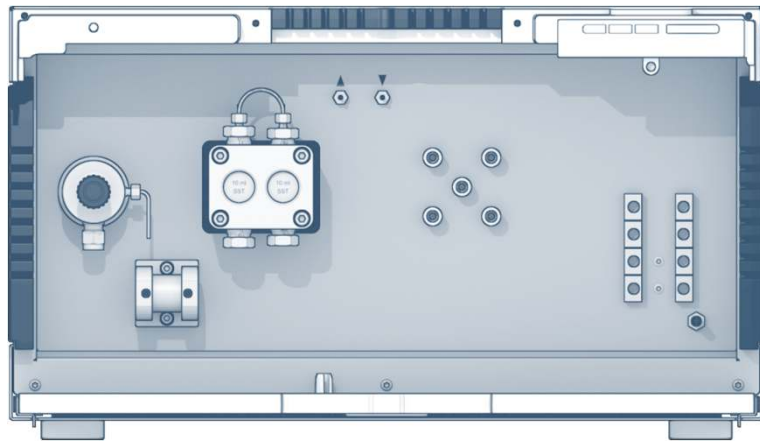

LPG

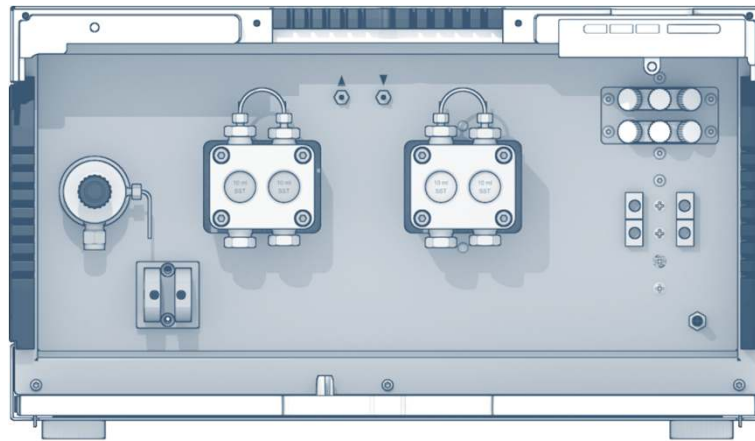

HPG

Sample injection/loading

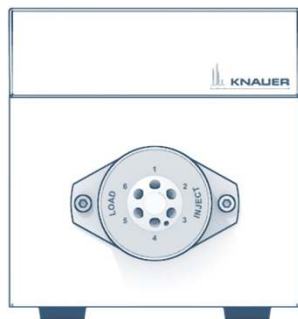

Load

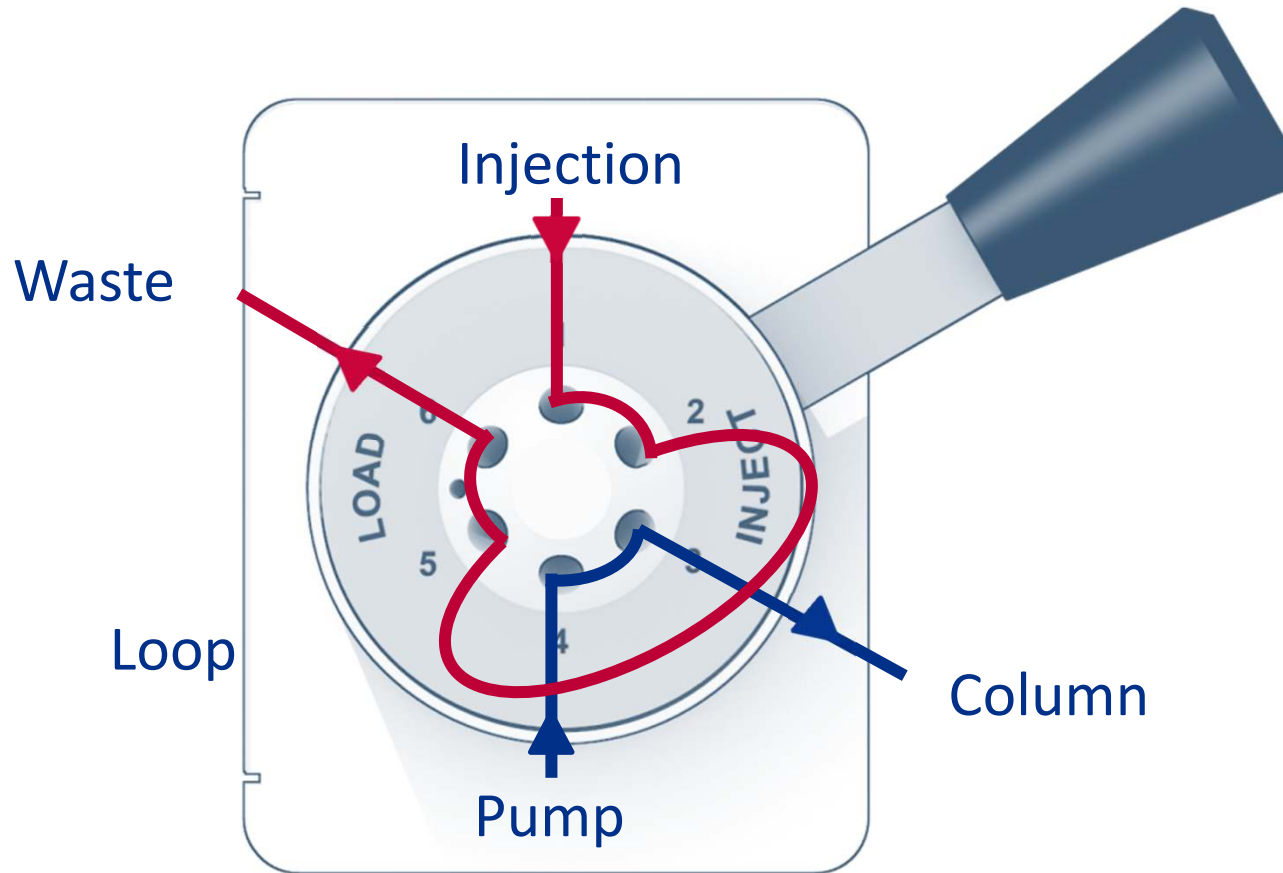

Inject

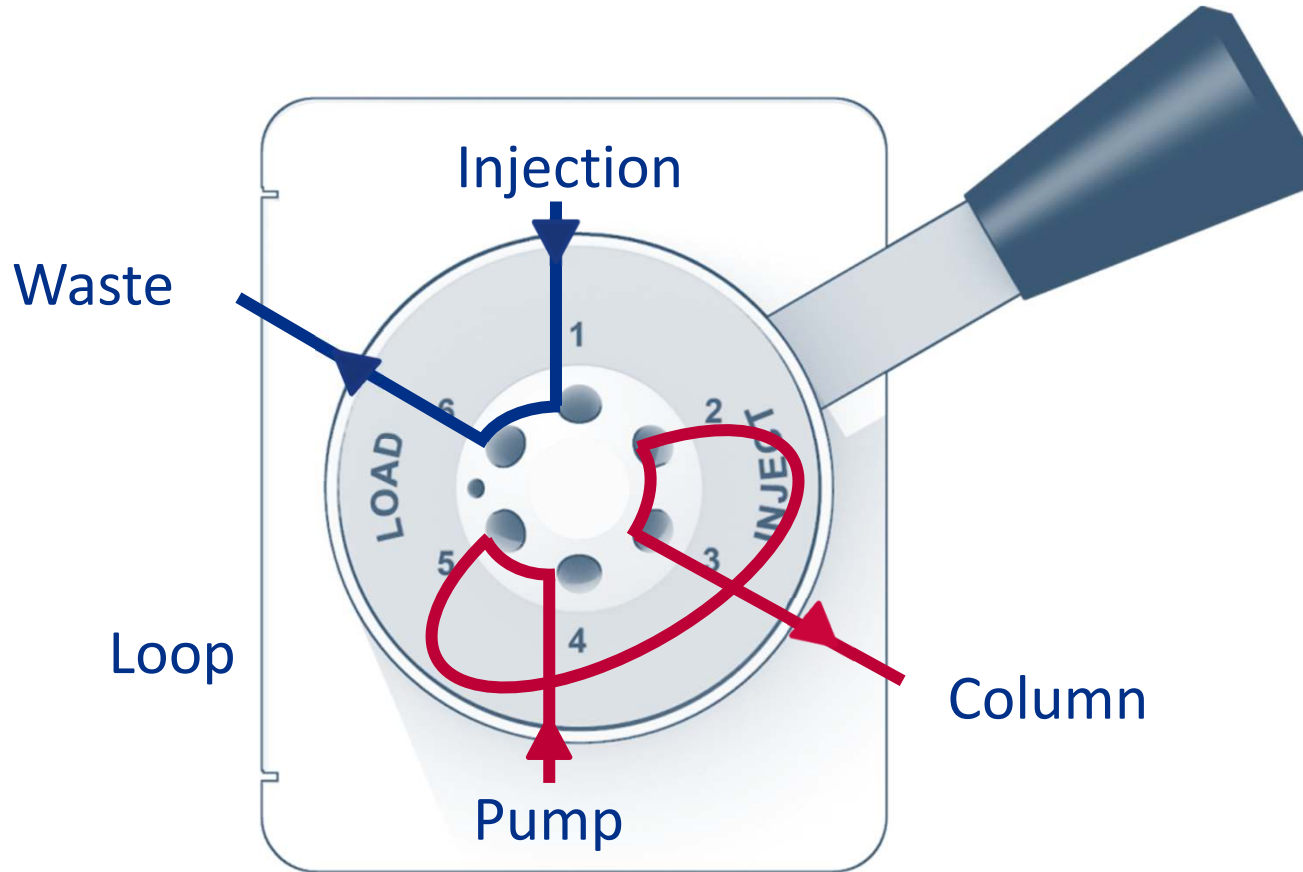

UV Detection of proteins

**Single
wavelength**



**Multiple
wavelength**

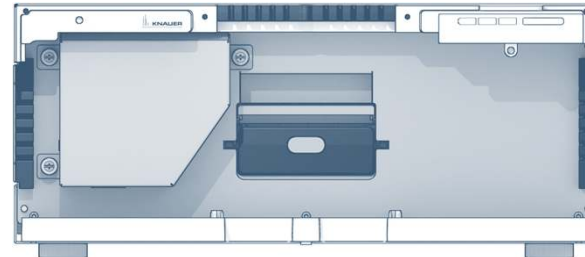

Detection

**Conductivity
monitor**

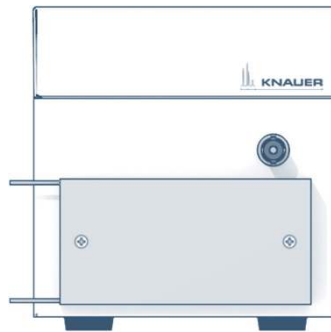

pH electrode



Fractionation

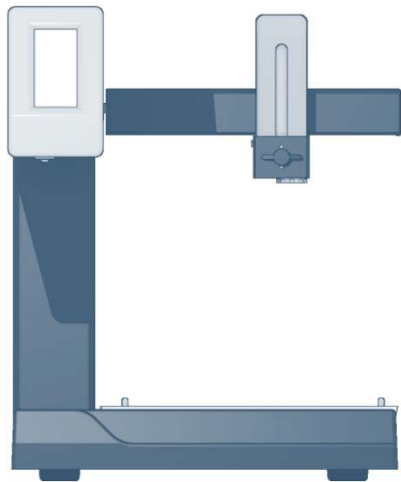

Aim is to
collect
purified
protein

Fractionation

Time/volume
based
fractionation

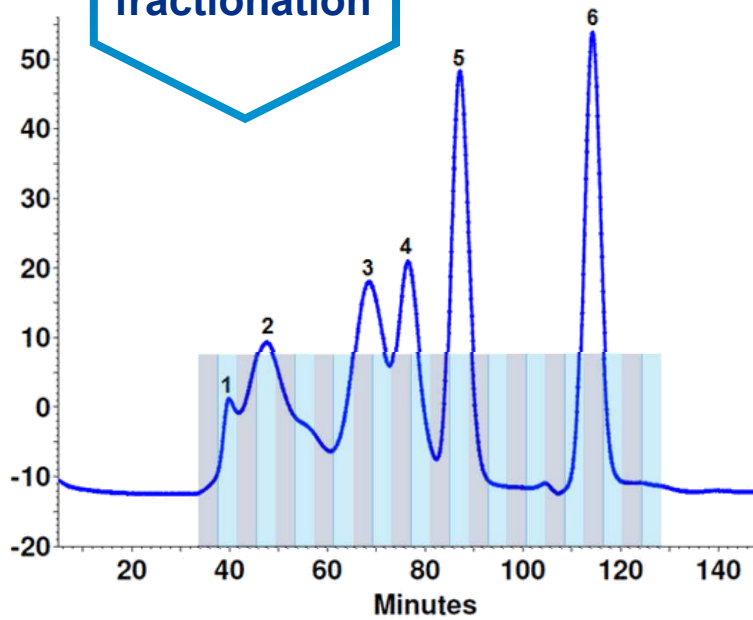

Threshold
based
fractionation

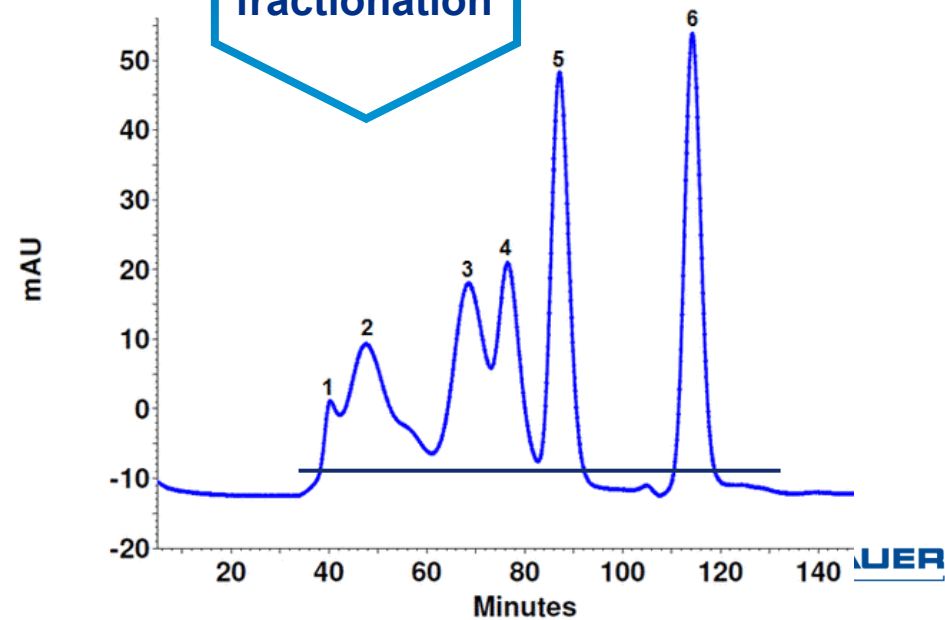

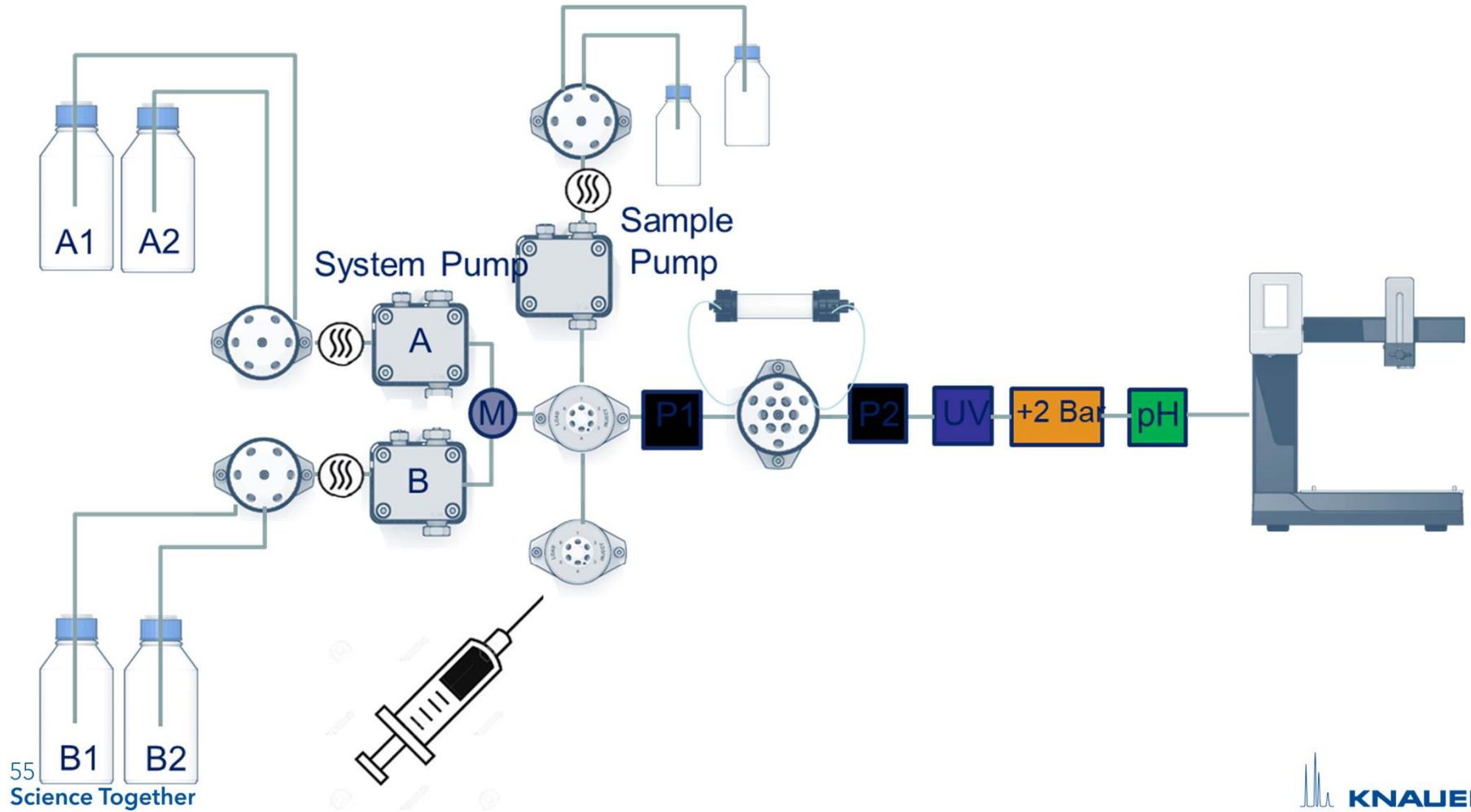



Route Z4-Z.I. Saint Gobain
1009 Jebel Jeloud-Tunisia
Tel. : (+216) 71 483 166
E-mail: contact@labtech.com.tn
Web : www.labtech.com.tn

Analytical
HPLC

Multi-Column
Chromatography,
SMB

Preparative
HPLC

FPLC

Osmometry

Dosing,
Metering,
Pumping

Detection



Route Z4-Z.I. Saint Gobain
1009 Jebel Jeloud-Tunisia
Tel. : (+216) 71 483 166
E-mail: contact@labtech.com.tn
Web : www.labtech.com.tn

Science Together



We separate molecules and
unite people.

KNAUER is an established
partner in science.

We are curious
and creative.